

# XPSBAC34AP

Estop or guard ,Harmony XPS, connected to supply terminals 48-240 V AC/DC , no inputs, screw





## Main

Range of Product	Harmony Safety Automation
Product or Component Type	Safety module
Safety module name	XPSBAC
Safety module application	For emergency stop and protective guard applications
Function of module	Emergency stop button with 2 NC contacts Guard monitoring with 1 or 2 limit switches
Safety level	Can reach PL e/category 4 for normally open relay contact ISO 13849-1 Can reach SILCL 3 for normally open relay contact IEC 62061 Can reach SIL 3 for normally open relay contact IEC 61508 Can reach PL c/category 1 for normally closed relay contact ISO 13849-1 Can reach SILCL 1 for normally closed relay contact IEC 62061 Can reach SIL 1 for normally closed relay contact IEC 61508
Safety reliability data	MTTFd > 30 years for normally open relay contact ISO 13849-1 Dcavg >= 99 % for normally open relay contact ISO 13849-1 PFHd = 1.01E-09 for normally open relay contact ISO 13849-1 HFT = 1 for normally open relay contact IEC 62061 PFHd = 1.01E-09 for normally open relay contact IEC 62061 SFF > 99% for normally open relay contact IEC 62061 HFT = 1 for normally open relay contact IEC 61508-1 PFHd = 1.01E-09 for normally open relay contact IEC 61508-1 SFF > 99% for normally open relay contact IEC 61508-1 Type = B for normally open relay contact IEC 61508-1 MTTFd > 30 years for normally closed relay contact ISO 13849-1 DC > 60 % for normally closed relay contact ISO 13849-1 PFHd = 1.01E-09 for normally closed relay contact ISO 13849-1 HFT=0 for normally closed relay contact IEC 62061 PFHd = 1.01E-09 for normally closed relay contact IEC 62061 SFF > 60% for normally closed relay contact IEC 62061 HFT=0 for normally closed relay contact IEC 61508-1 PFHd = 1.01E-09 for normally closed relay contact IEC 61508-1 SFF > 60% for normally closed relay contact IEC 61508-1 Type = B for normally closed relay contact IEC 61508-1
Electrical circuit type	NC pair
Connections - terminals	Removable screw terminal block, 0.2...2.5 mm <sup>2</sup> solid or flexible Removable screw terminal block, 0.25...2.5 mm <sup>2</sup> flexible with ferrule single conductor Removable screw terminal block, 0.2...1.5 mm <sup>2</sup> solid or flexible twin conductor Removable screw terminal block, 2 x 0.25...1 mm <sup>2</sup> flexible with ferrule without cable end, with bezel Removable screw terminal block, 2 x 0.5...1.5 mm <sup>2</sup> flexible with ferrule with cable end, with bezel
[Us] Rated Supply Voltage	48...240 V AC - 15...10 % 48...240 V DC - 20...20 %

## Complementary

Synchronisation time between inputs	Unlimited
Type of start	Automatic/manual/monitored
Power consumption in W	2.0 W 48...240 V DC
Power consumption in VA	6.0 VA 48...240 V AC 50/60 Hz
Input protection type	Internal, electronic
Safety outputs	4 NO + 1 NC
Safety inputs	0
Input compatibility	Normally closed circuit ISO 14119 XC limit switch ISO 14119 Mechanical contact ISO 14119 Normally closed circuit ISO 13850
Input terminal	Power supply
[Ie] rated operational current	5 A AC-1 3 A AC-15 5 A DC-1 3 A DC-13 3 A AC-1 1 A AC-15 3 A DC-1 1 A DC-13
Control outputs	0
[Ith] conventional free air thermal current	6 A
Associated fuse rating	10 A gG NO relay output circuit IEC 60947-1
Minimum output current	10 mA relay output
Minimum output voltage	5 V relay output
Response time	60 ms at 48...240 V AC/DC
[Ui] rated insulation voltage	300 V 2)EN/IEC 60947-1
[Uimp] rated impulse withstand voltage	4 kV II EN/IEC 60947-1
Local signalling	LED green power power ON LED red error error LED yellow state status LED yellow start1 start input LED yellow start2 start input
Mounting Support	35 mm symmetrical DIN rail
Depth	4.72 in (120 mm)
Height	3.94 in (100 mm)
Width	0.89 in (22.5 mm)
Net Weight	0.44 lb(US) (0.200 kg)

## Environment

Ambient air temperature for operation	-13...131 °F (-25...55 °C)
Standards	IEC 60947-5-1 IEC 61508-1 functional safety standard IEC 61508-2 functional safety standard IEC 61508-3 functional safety standard IEC 61508-4 functional safety standard IEC 61508-5 functional safety standard IEC 61508-6 functional safety standard IEC 61508-7 functional safety standard ISO 13849-1 functional safety standard IEC 62061 functional safety standard
Product Certifications	TÜV cULus
IP degree of protection	IP20 terminals)EN/IEC 60529 IP40 housing)EN/IEC 60529 IP54 mounting area)EN/IEC 60529
Relative Humidity	5...95 % non-condensing

## Ordering and shipping details

Category	22477-SAFETY MODULES (PREVENTA)
Discount Schedule	SAF2
GTIN	3606482034020
Nbr. of units in pkg.	1
Package weight(Lbs)	10.76 oz (305.0 g)
Returnability	Yes
Country of origin	ID

## Packing Units

Unit Type of Package 1	PCE
Package 1 Height	2.56 in (6.5 cm)
Package 1 width	5.31 in (13.5 cm)
Package 1 Length	6.10 in (15.5 cm)
Unit Type of Package 2	S03
Number of Units in Package 2	16
Package 2 Weight	12.36 lb(US) (5.607 kg)
Package 2 Height	11.81 in (30.0 cm)
Package 2 width	11.81 in (30.0 cm)
Package 2 Length	15.75 in (40.0 cm)
Package 3 Height	11.81 in (30 cm)

## Offer Sustainability

Sustainable offer status	Green Premium product
California proposition 65	WARNING: This product can expose you to chemicals including: Lead and lead compounds, which is known to the State of California to cause cancer and birth defects or other reproductive harm. For more information go to <a href="http://www.P65Warnings.ca.gov">www.P65Warnings.ca.gov</a>
REACH Regulation	<a href="#">REACH Declaration</a>
EU RoHS Directive	Pro-active compliance (Product out of EU RoHS legal scope) <a href="#">EU RoHS Declaration</a>
Mercury free	Yes
RoHS exemption information	<a href="#">Yes</a>
China RoHS Regulation	<a href="#">China RoHS Declaration</a>
Environmental Disclosure	<a href="#">Product Environmental Profile</a>
Circularity Profile	<a href="#">End Of Life Information</a>
WEEE	The product must be disposed on European Union markets following specific waste collection and never end up in rubbish bins.

Dimensions

Front and Side Views

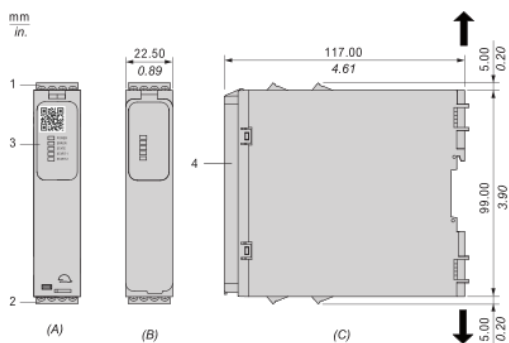

(A) : Product drawing

(B) : Screw clamp terminal







(C) : Side view

(1) : Removable terminal blocks, top

(2) : Removable terminal blocks, bottom

(3) : LED indicators

(4) : Sealable transparent cover

mm in.	7.0-8.0 0.28-0.31					
mm <sup>2</sup>		0,2... 2,5	0,25...2,5	0,2... 1,5	0,25...1	0,5... 1,5
AWG		24... 12	24...12	24...16	24...18	20...16
	Ø 3,5 mm (0.14 in)				Nm	0.5... 0.6
					lb-in	4.4... 5.3

## Mounting to DIN rail

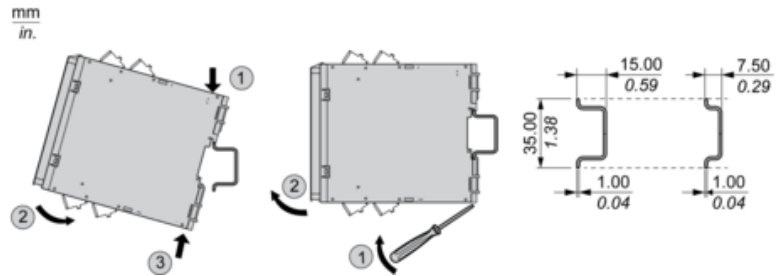

## Screw-mounting

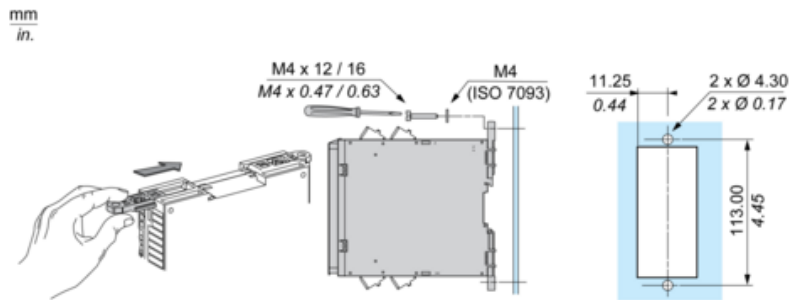

## Wiring Diagram

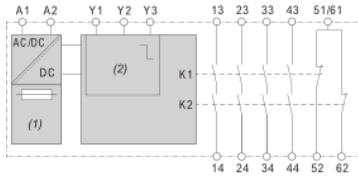

(1) : A1-A2 (Power supply)

(2) : Y1 (Control output of Start/Restart input), Y2 (Input channel for automatic/manual start/restart), Y3 (Input channel for monitored start/restart with falling edge)

13-14-23-24-33-34-43-44-51/61-52-62 : Terminals of the safety-related outputs